

Atlas Wooden Pergola W6.0m x D3.0m

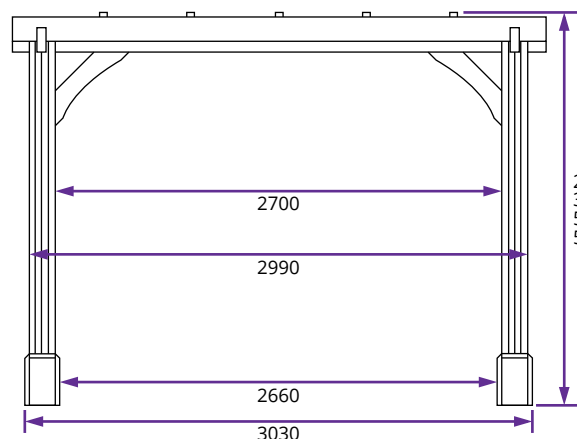
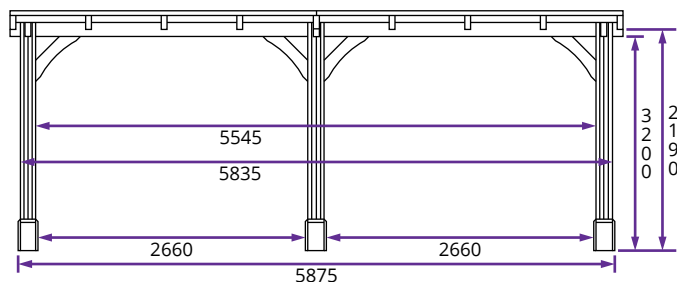
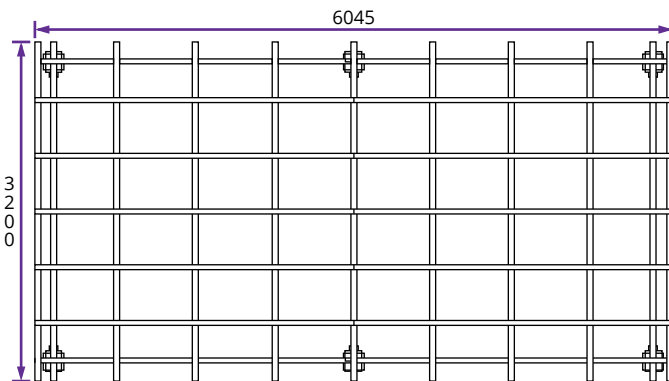

Specification

- **Overall External Dimensions:** 6.04m x 3.20m (19' 9" x 10' 5")
- **External Width:** 5.84m (19' 1")
- **External Depth:** 3.03m (9' 11")
- **Ridge Height:** 2.35m (7' 8")
- **Timber:** Pressure Treated Spruce
- **Uprights:** 145mm x 145mm

- **Approx. Assembly Time:** 1 - 2 Days*

*This is an approximate time only, based on 2 people. Assembly time may vary depending on season/weather conditions, foundation type, ability of those constructing, etc

- **Guarantee:** 10 Years on Pressure Treated Timber against Rot and Insect Infestation
- **Please Note:** All fixings needed for assembly are supplied