

Avon Grande Log Cabin

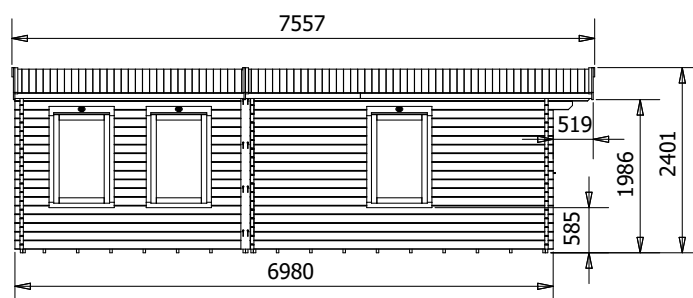
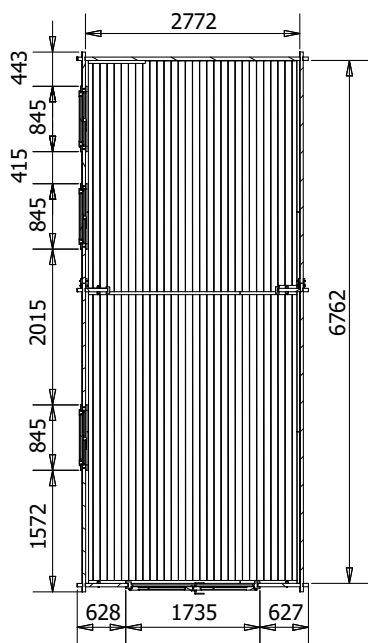
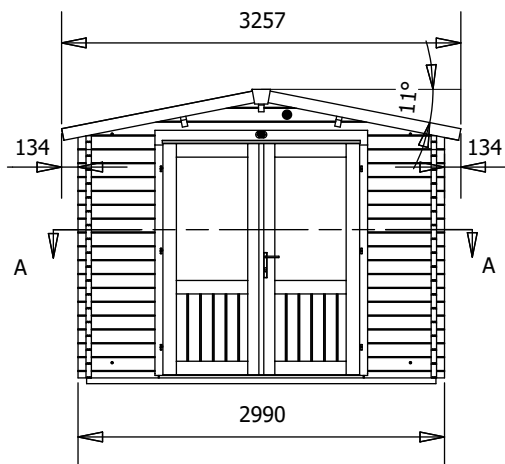

Specification

- Overall External Dimensions: 3.25m x 7.51m (10' 7" x 24' 7")
- External Width: 2.99m (9' 9")
- External Depth: 6.76m (22' 10")
- Internal Width: 2.77m (9' 1")
- Internal Depth: 6.76m (22' 2")
- Internal Area (m²): 18.73m²
- Ridge Height: 2.38m (7' 9")
- Internal Eaves Height: 2.02m (6' 7")
- Roof Overhang: 0.58m (1' 10")
- Roof Purlins: 140mm x 45mm
- Roof & Floor Thickness: 19mm Tongue and Groove
- Floor Bearers: Pressure Treated
- Storm Braces: Included

- Door Locking System: Multi-point lock
- Door Height (Walkthrough Height): 1.82m
- Door Width (Walkthrough Width): 1.55m
- Number of Windows: 3
- Window Opening Size: 0.66m x 1.08m (2' 1" x 3' 6")
- Glazing Material: 24mm double glazed
- Ventilation: 2 Plastic Vents Included
- Approx. Assembly Time: 2 Days*

*This is an approximate time only, based on 2 people. Assembly time may vary depending on season/weather conditions, foundation type, ability of those constructing, etc