

Assassin Log Cabin with Gazebo

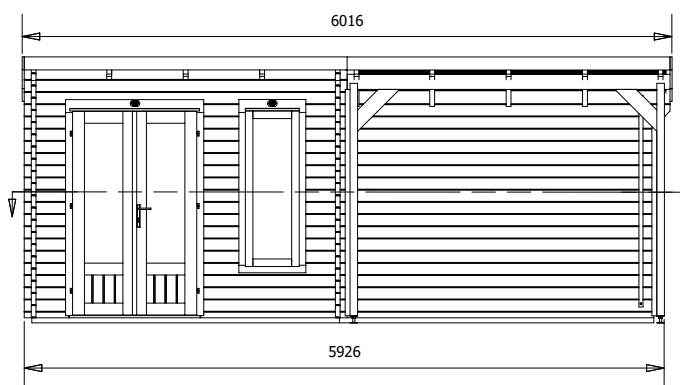
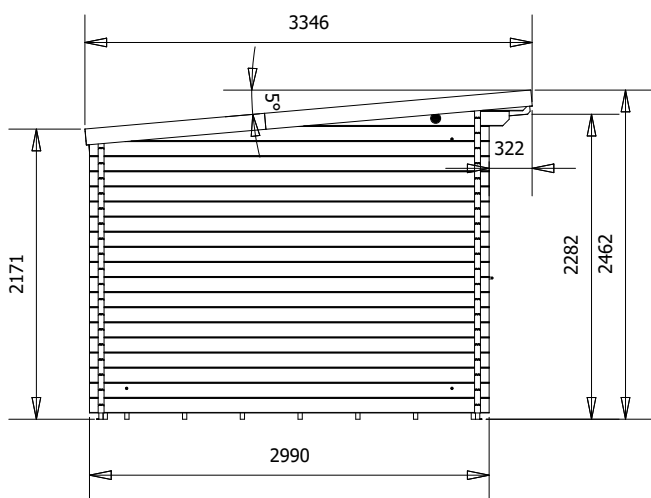
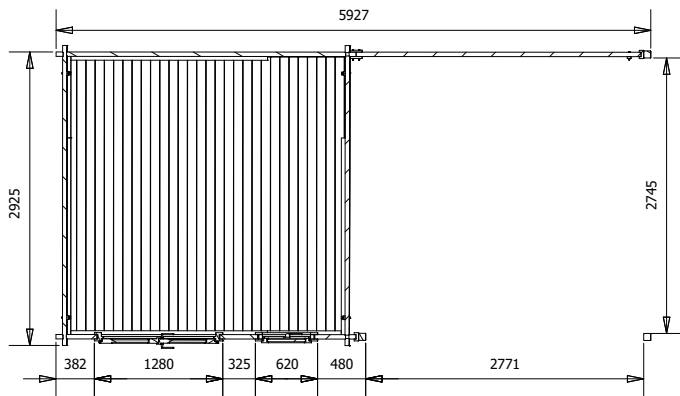

Specification

- **Please Note:** All sizes quoted are nominal
- **Overall External Dimensions:** 6.01m x 3.34m (19' 8" x 10' 11")
- **External Width:** 5.92m (9' 5")
- **External Depth:** 2.99m (9' 9")
- **Internal Width:** 2.77m (9' 1")
- **Internal Depth:** 2.77m (9' 1")
- **Internal Area (m²):** 7.67m²
- **Roof Overhang:** 0.38m (1' 2")
- **Ridge Height:** 2.46m (8' 0")
- **Internal Eaves Height Front (to under the roof boards):** 2.32m (7' 7")
- **Internal Eaves Height Front (to under the roof purlins):** 2.18m (7' 1")
- **Internal Eaves Height Back (to under the roof boards):** 2.07m (6' 9")
- **Internal Eaves Height Back (to under the roof purlins):** 1.93m (6' 3")

- **Roof Thickness:** 19mm Tongue & Groove
- **Floor Thickness:** 19mm Tongue & Groove
- **Floor Bearers:** Pressure Treated for Longevity
- **Wall Thickness:** 45mm
- **External Width (Gazebo):** 3.00m (9' 10")
- **External Depth (Gazebo):** 2.89m (9' 5")
- **Internal Width (Gazebo):** 2.77m (9' 1")
- **Internal Depth (Gazebo):** 2.74m (8' 11")
- **Internal Area (m²) (Gazebo):** 7.59m²
- **Window Opening Size:** 0.43m x 1.37m (1' 4" x 4' 5")
- **Assembly Time:** 2 Days
- **Roof Purlins:** 140 x 45mm

This time is an approximation, based on two people building the basic product with no added extras. Assembly time may vary with additional items such as roof shingles, or external circumstances like the weather