

EvilGenius Log Cabin and Workshop

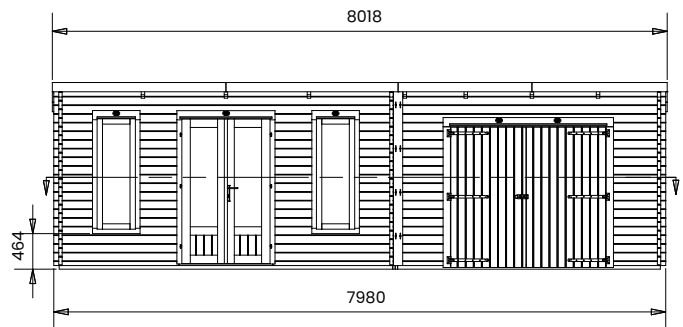
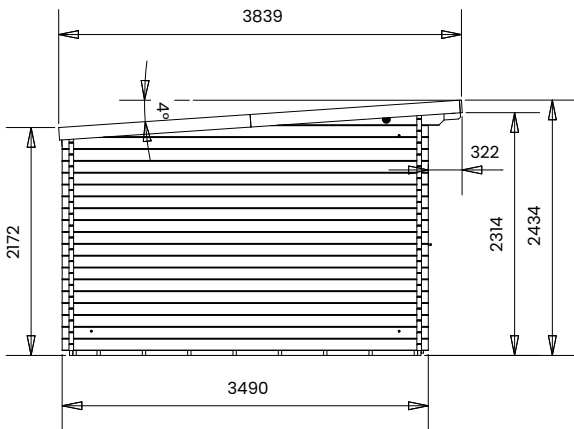
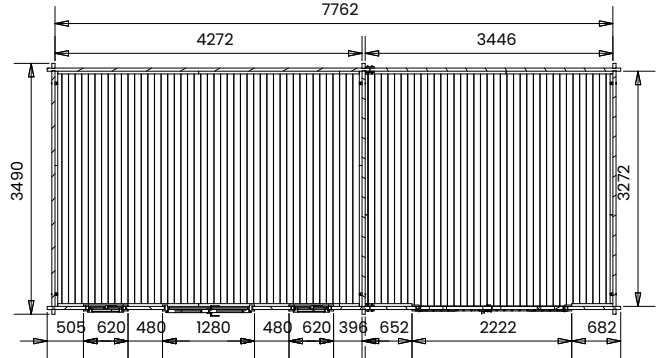

Specification

- Please Note: All sizes quoted are nominal
- Overall External Dimensions: 8.01m x 3.83m (26' 3" x 12' 6")
- External Width: 7.98m (26' 2")
- External Depth: 3.49m (11' 5")
- Internal Width: 7.76m (25' 5")
- Internal Depth: 3.27m (10' 8")
- Internal Area (m²): 25.38m²
- Main Room Internal Width: 4.27m (14' 0")
- Main Room Internal Depth: 3.27m (10' 8")
- Main Room Internal Area (m²): 13.96
- Store Room Internal Width: 3.44m (11' 3")
- Store Room Internal Depth: 3.27m (10' 8")
- Store Room Internal Area (m²): 11.25
- Roof Overhang: 0.32m (1' 0")
- Floor Bearers: Pressure Treated for Longevity
- Floor Thickness: 19mm Tongue & Groove

- Internal Eaves Height Back (to under the roof boards): 2.07m (6' 9")
- Internal Eaves Height Back (to under the roof purlins): 1.93m (6' 4")
- Main Door Height (Walkthrough Height): 1.82m (5' 11")
- Main Door Width (Walkthrough Width): 1.11m (3' 7")
- Side Door Height (Walkthrough Height): 1.79m (5' 10")
- Side Door Width (Walkthrough Width): 1.99m (6' 6")
- Walls: 100% Slow-Grown Spruce
- Wall Thickness: 45mm
- Wall U-Value (W/m²K): 1.93 W/m²K
- 24mm Double Glazing: Included as Standard
- Glazing Material: 4mm Toughened Glass
- Window Opening Size: 0.43m x 1.37m (1' 4" x 4' 5")
- Roof Thickness: 19mm Tongue & Groove
- Roof Covering Options: None, Felt or Shingles