

GhostFlower Log Cabin

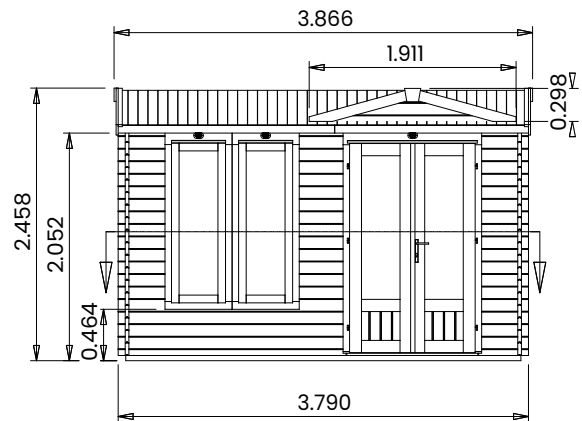
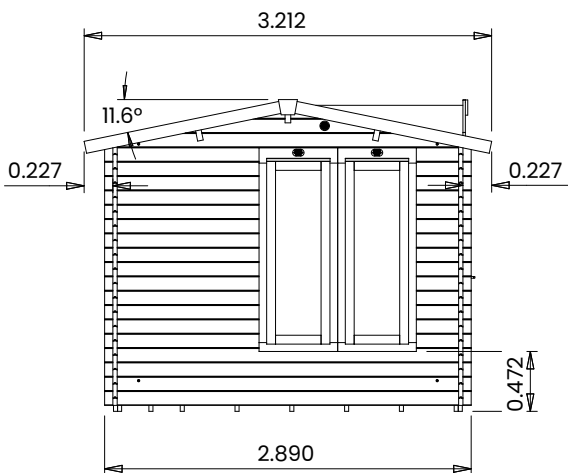
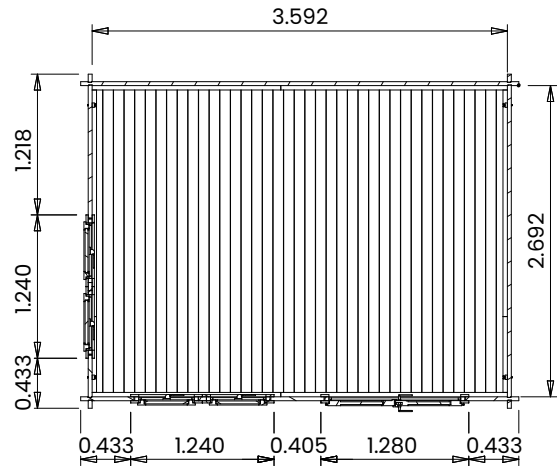

Specification

- **Please Note:** All sizes quoted are nominal
- **Overall External Dimensions:** 3.866m x 3.212m (12' 8" x 10' 6")
- **External Width:** 3.790m (12' 5")
- **External Depth:** 2.890m (9' 5")
- **Internal Width:** 3.592m (11' 9")
- **Internal Depth:** 2.692m (8' 10")
- **Internal Area (m²):** 9.670m²
- **Ridge Height:** 2.458m (8' 0")
- **Internal Eaves Height:** 2.078m (6' 9") Plenty of Headroom!
- **Roof Overhang:** 0.227m (0' 9")
- **Wall Thickness:** 34mm
- **Floor Thickness:** 19mm
- **Roof Thickness:** 19mm
- **Roof Purlins:** 140 x 45mm
- **Floor Bearers:** Pressure Treated for Longevity
- **Double Door walkthrough height:** 1.821m (5' 11")
- **Double Door walkthrough width:** 1.096m (3' 7")
- **Door Locking System:** Multi-point lock
- **Window Opening Size:** 1.371m x 0.436m (4' 5" x 1' 5")
- **Included as Standard:** Plastic Vents, Adjustable Storm Braces, Assembly Instructions and Fixings
- **Please Note:** All wood is planed, pre-cut (with the exception of trims), and pre notched for quick and easy construction
- **Fixings:** All Items Supplied
- **Guarantee:** 10 Years on Pressure Treated Timber against Rot and Insect Infestation
- **Assembly Time:** 2 Days*