

ChallengeFort Climbing Frame

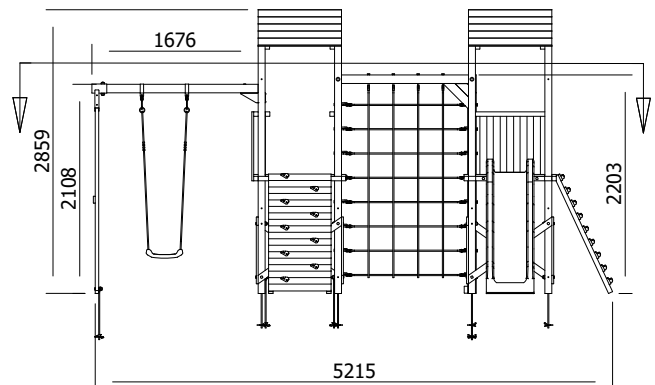
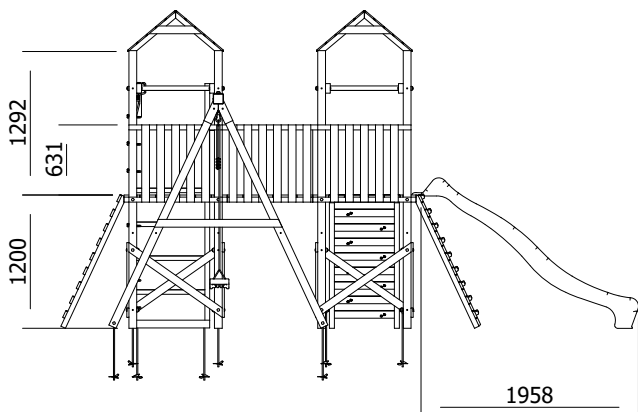
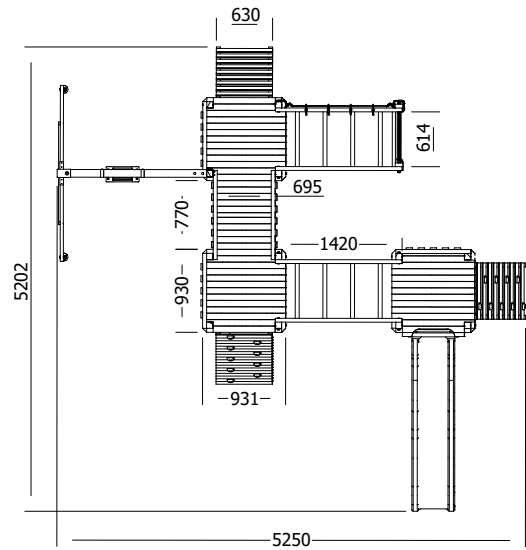

Specification

- External Width: 5.250m (17' 2.75")
- External Depth: 5.202m (17' 0.75")
- Overall Height: 2.860m (9' 4.5")
- Platform Height from ground: 1.200m
- Tower Platform Width: 0.930m (3' 0.5")
- Tower Platform Depth: 0.930m (3' 0.5")
- Tower Platform Area (m²): 0.86m²
- Balcony/Bridge Platform Width: 0.695m (2' 3.25")
- Balcony/Bridge Platform Depth: 0.770m (2' 6.25")
- Balcony/Bridge Platform Area (m²): 0.54m²
- Platform Thickness: 19mm
- Platform Framing: 45mm
- Balustrade Height: 0.630m (2' 0.75")
- Balustrade Timber Thickness: 45mm
- Number of Children: 10 Maximum at One Time
- Number of Children on Platform: 2 Maximum at One Time

- Weight of Children: 50kg
- Maximum Combined User Weight: 500kg
- Suitable Age Range: 3 - 14 Years Old
- Independently Tested Safety Standard: EN71
- Timber: Pressure Treated Spruce
- Approx. DIY Assembly Time: 2 Days. This is an approximate time only, based on 2 people. Assembly time may vary depending on season/weather conditions, foundation type, ability of those constructing, etc