

MegaFort Climbing Frame

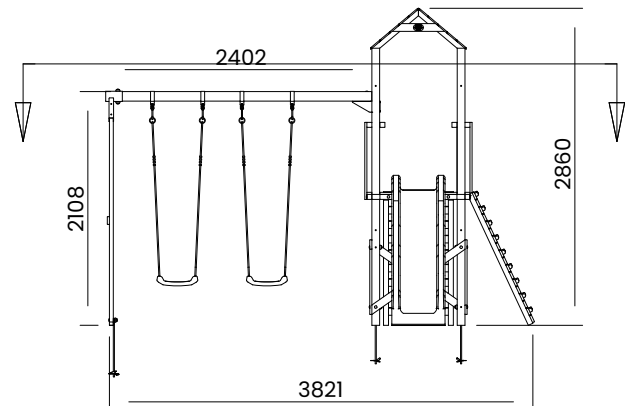
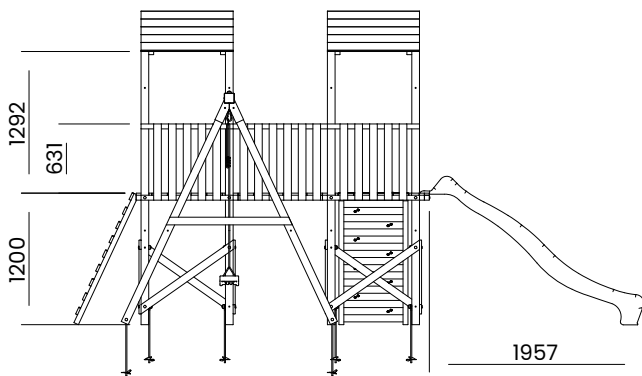
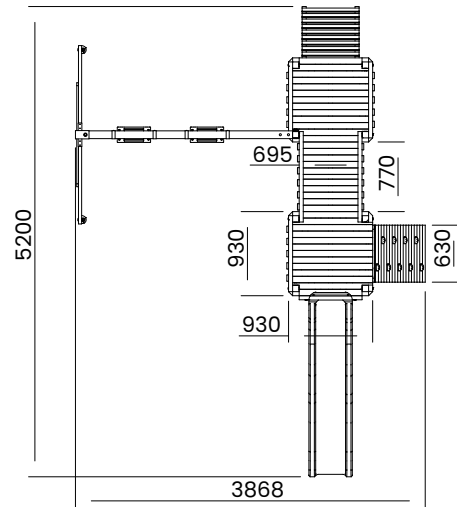

Specification

- External Width: 3.868m (12' 8.25")
- External Depth: 5.200m (17' 0.75")
- Overall Height: 2.860m (9' 4.5")
- Platform Height from ground: 1200mm
- Tower Platform Width: 0.930m (3' 0.5")
- Tower Platform Depth: 0.930m (3' 0.5")
- Tower Platform Area (m²): 0.86m²
- Balcony/Bridge Platform Width: 0.695m (2' 3.25")
- Balcony/Bridge Platform Depth: 0.770m (2' 6.25")
- Balcony/Bridge Platform Area (m²): 0.54m²
- Platform Thickness: 19mm
- Platform Framing: 45mm
- Balustrade Height: 0.631m (2' 0.75")
- Balustrade Timber Thickness: 45mm
- Timber: Pressure Treated Spruce
- Number of Children: 7 Maximum at One Time
- Number of Children on Platform: 2 Maximum at One Time
- Weight of Children: 50kg
- Maximum Combined User Weight: 350kg
- Suitable Age Range: 3 - 14 Years Old
- Independently Tested Safety Standard: EN71
- Safety Ground Anchors: 6 Included
- Wrap Around Safety Swing Hooks: 2 Included
- Slide Construction: Single Piece Durable Plastic
- Climbing Wall: Included with Professional Quality Climbing Stones