

# SquirrelFort Climbing Frame HIGH Platform

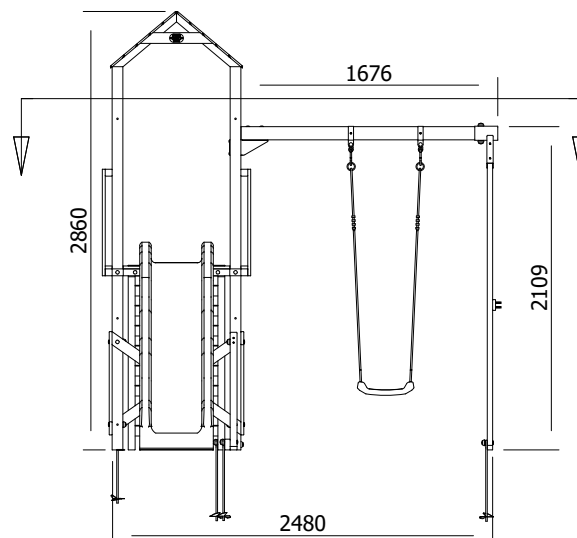
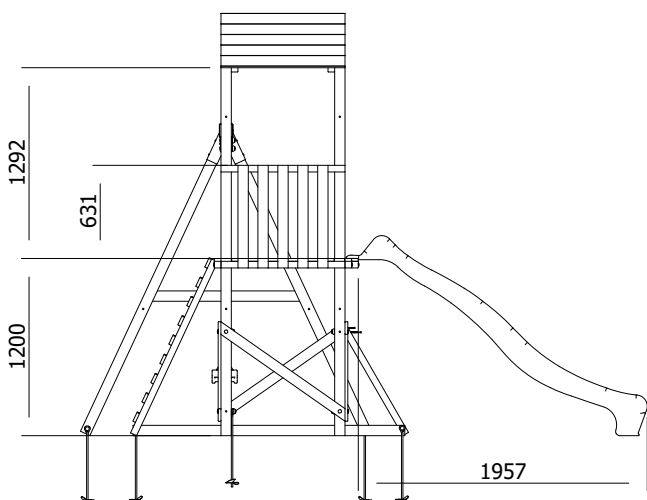
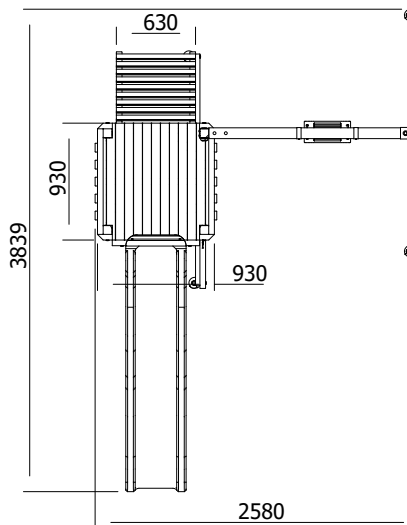

## Specification

- External Width: 2.580m (8' 5.5")
- External Depth: 3.839m (12' 7.25")
- Tower Platform Width: 0.93m (3' 0.5")
- Tower Platform Depth: 0.93m (3' 0.5")
- Tower Platform Area (m<sup>2</sup>): 0.86m<sup>2</sup>
- Overall Height: 2.86m (9' 4.5")
- Platform Height from ground: 1.200m
- Number of Children: 3 Maximum at one time
- Number of Children on Platform: 2 Maximum at one time
- Weight of Children: 50kg Maximum
- Maximum Combined User Weight: 150kg

- Platform Thickness: 19mm
- Platform Framing: 45mm
- Balustrade Height: 0.631m (2' 1")
- Balustrade Timber Thickness: 45mm
- Approx. DIY Assembly Time: 1 Days. This is an approximate time only, based on 2 people. Assembly time may vary depending on season/weather conditions, foundation type, ability of those constructing, etc

# SquirrelFort Climbing Frame LOW Platform

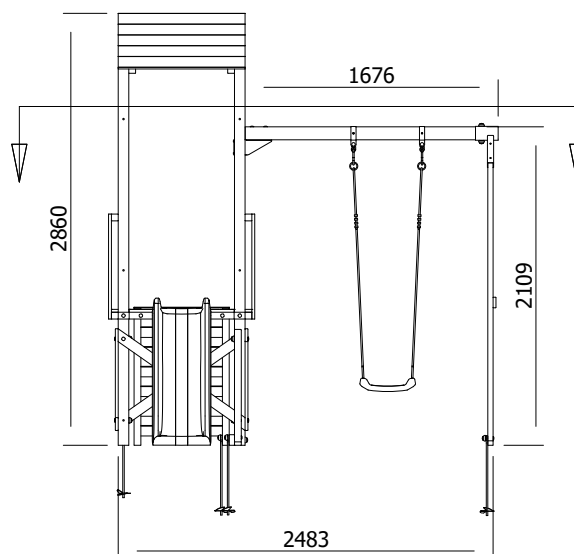
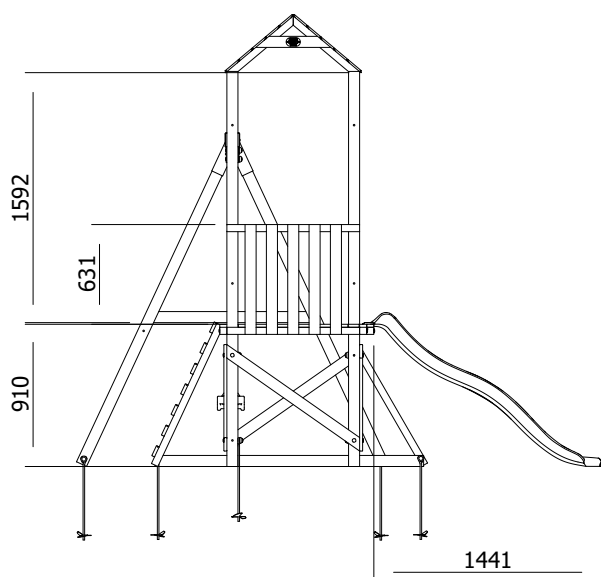
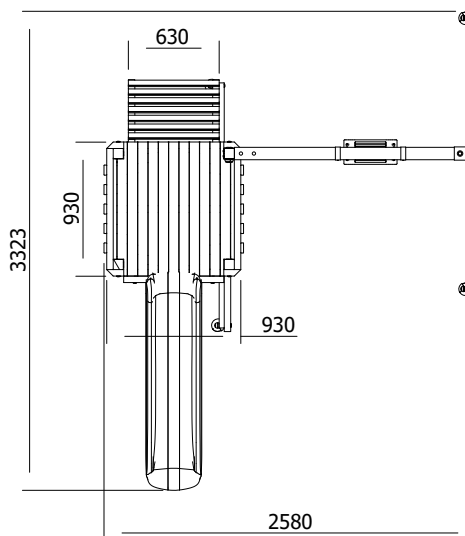

## Specification

- External Width: 2.580m (8' 5.5")
- External Depth: 3.323m (10' 10.75")
- Tower Platform Width: 0.93m (3' 0.5")
- Tower Platform Depth: 0.93m (3' 0.5")
- Tower Platform Area (m<sup>2</sup>): 0.86m<sup>2</sup>
- Overall Height: 2.86m (9' 4.5")
- Platform Height from ground: 900mm
- Number of Children: 3 Maximum at one time
- Number of Children on Platform: 2 Maximum at one time
- Weight of Children: 50kg Maximum
- Maximum Combined User Weight: 150kg

- Platform Thickness: 19mm
- Platform Framing: 45mm
- Balustrade Height: 0.631m (2' 1")
- Balustrade Timber Thickness: 45mm
- Approx. DIY Assembly Time: 1 Days. This is an approximate time only, based on 2 people. Assembly time may vary depending on season/weather conditions, foundation type, ability of those constructing, etc