

SquirrelFort Climbing Frame HIGH Platform

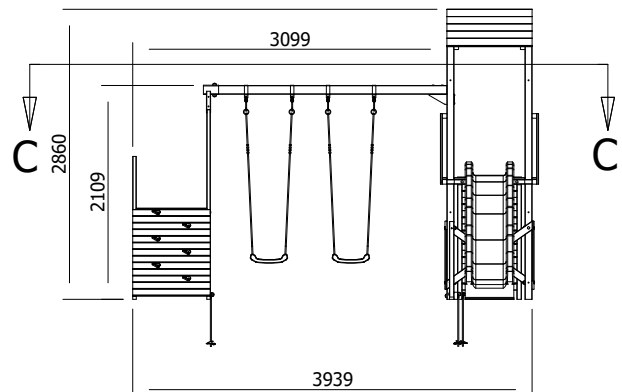
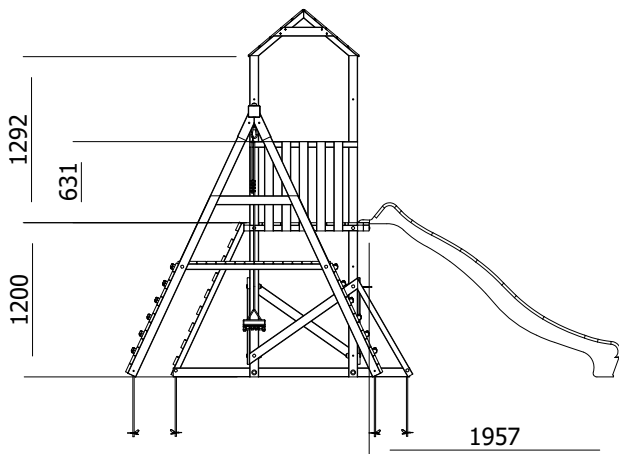
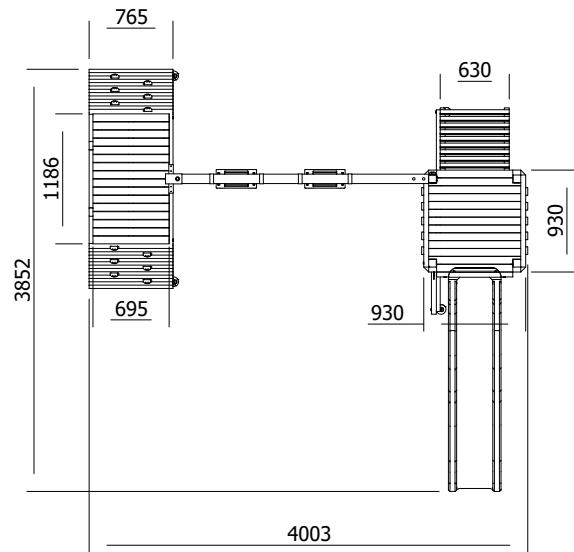

Specification

- External Width: 4.003m (13' 1.5")
- External Depth: 3.852m (12' 7.75")
- Tower Platform Width: 0.93m (3' 0.5")
- Tower Platform Depth: 0.93m (3' 0.5")
- Tower Platform Area (m²): 0.86m²
- Overall Height: 2.86m (9' 4.5")
- Platform Height from ground: 1.200m
- Number of Children: 5 Maximum at one time
- Number of Children on Platform: 2 Maximum at one time
- Weight of Children: 50kg Maximum
- Maximum Combined User Weight: 250kg

- Platform Thickness: 19mm
- Platform Framing: 45mm
- Balustrade Height: 0.631m (2' 1")
- Balustrade Timber Thickness: 45mm
- Approx. DIY Assembly Time: 1 Days. This is an approximate time only, based on 2 people. Assembly time may vary depending on season/weather conditions, foundation type, ability of those constructing, etc

SquirrelFort Climbing Frame LOW Platform

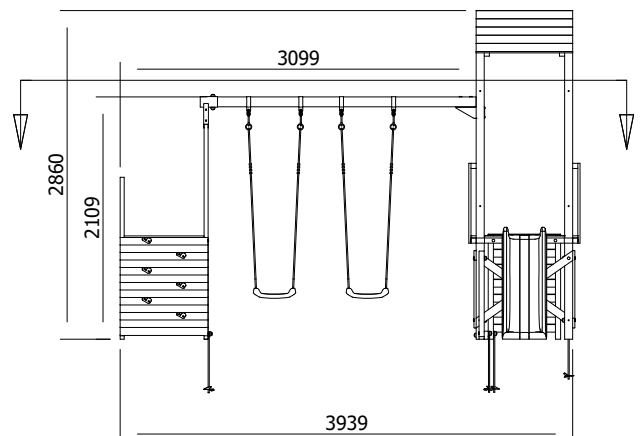
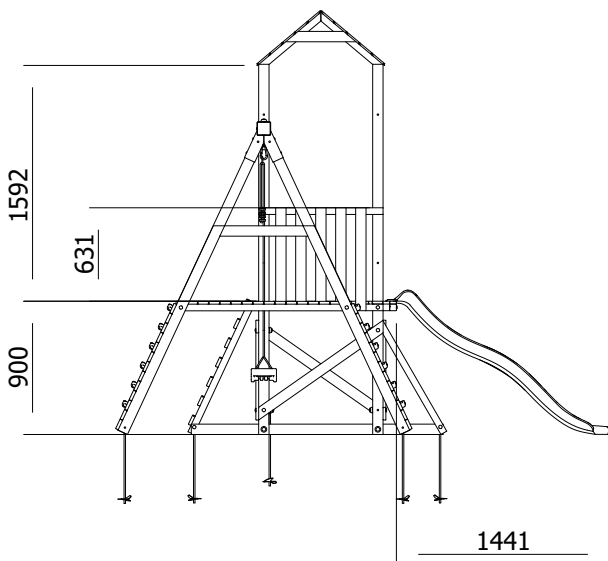
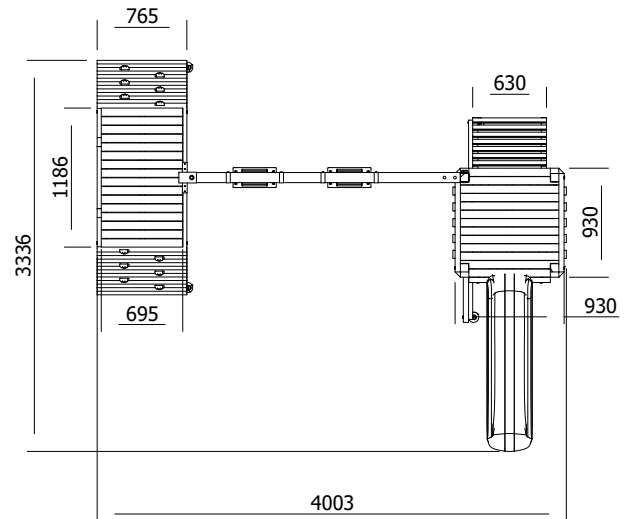

Specification

- External Width: 4.003m (13' 1.5")
- External Depth: 3.336m (10' 11.25")
- Tower Platform Width: 0.93m (3' 0.5")
- Tower Platform Depth: 0.93m (3' 0.5")
- Tower Platform Area (m²): 0.86m²
- Overall Height: 2.86m (9' 4.5")
- Platform Height from ground: 900mm
- Number of Children: 5 Maximum at one time
- Number of Children on Platform: 2 Maximum at one time
- Weight of Children: 50kg Maximum
- Maximum Combined User Weight: 250kg

- Platform Thickness: 19mm
- Platform Framing: 45mm
- Balustrade Height: 0.631m (2' 1")
- Balustrade Timber Thickness: 45mm
- Approx. DIY Assembly Time: 1 Days. This is an approximate time only, based on 2 people. Assembly time may vary depending on season/weather conditions, foundation type, ability of those constructing, etc